

KAUPA INTERNATIONAL CO, LTD

PRODUCT DETAIL

ET-9338 MERCEDES CDI INJECTOR NOZZLE TOOL SET



Applicable to Mercedes CDI engines OM 611, 612, 613, 628, 646*, 647, 648 etc. (*not suitable for 646 EVO)

The injector nozzle puller with slide hammer is designed for the removal of injection nozzles which are only slightly seized in place without having to dismantle them. The injector nozzle puller with pull spindle enables the removal of very tight-fitting or stuck injector nozzles to be performed directly on the vehicle. It is not necessary to remove the cylinder head from the vehicle using either of the pullers. The cleaning tool allows the injection nozzle mounting hole, the nozzle seat, and the small aperture leading to the combustion chamber to be cleaned in a single operation. By screwing the compressed air adapter into the glow plug bore and injecting air into the combustion chamber, impurities are prevented from entering the latter.

The screw tap with drill bit is used for re cutting and cleaning the tapped hole for the nozzle holder. This procedure is important before re-installing the injector nozzle.

KAUPA INTERNATIONAL CO, LTD

PRODUCT DETAIL

ET-9339 PLIERS FOR CLUTCH MASTER CYLINDER PISTON ROD



- Suitable for : Vauxhall / Opel : Astra-J, Signum, Vectra-C Audi : A1 (8X), A3 (8P), A4 (B7), A6 (C6) VW : Golf (1K1), Passat (3B6), Eos (1F) etc.
- The pliers are designed to release the clutch master cylinder piston rod from the clutch pedal quickly and easily.
- Very useful tool when removing a clutch master cylinder/pedal support bracket.

KAUPA INTERNATIONAL CO, LTD

PRODUCT DETAIL

ET-9340 EXHAUST PIPE CLAMP PLIERS (PAS GROUP)



- **Opens the pipe connector clamps on the exhaust system, for example in Citroen, Peugeot, Renault, Nissan and Opel models.**
- **The screw remains in the clamp after loosening, it guarantees the fast application.**

KAUPA INTERNATIONAL CO, LTD

PRODUCT DETAIL

ET-9341 FLYWHEEL LOCKING TOOL FOR BMW/MINI



- To hold the flywheel for removal and installation.
- Suitable for engine : N40, N42, N43, N45(T), N46(T), N51, N52, N53, N54, N62, N73, M47TU, M54, M57T2(TU), S85, W17.

KAUPA INTERNATIONAL CO, LTD

PRODUCT DETAIL

ET-9342 BMW PETROL INJECTOR EXTRACTOR



Application:

- **Petrol injector extractor with slide hammer**
- **Applications: BMW N43 (1.6/2.0lt), N53/N54 (2.5/3.0lt) Petrol engines**
- **Equivalent to OEM 13 0 180**
- **Where possible run engine prior to injector removal till the engine block is warm to the touch.**
- **Designed to be used in accordance with OEM instructions**



2-7, Ln 108 West, Yongfeng Rd., Taiping Dist., Taichung, Taiwan

TEL: 886 4 22778689 FAX: 886 4 22778289

KAUPA INTERNATIONAL CO, LTD

PRODUCT DETAIL

ET-9343 FUEL LINE CONNECTOR TOOL



Suitable for VW-Audi, Sear and Skoda 2.0,2.7 and 3.0 TDI Common Rail Diesel engine; as fitted toVWEos,golfV,GolfVI,Jetta,Passat,PassatCC,Scirocco,Tiguan,Transporter T5, Phaeton;Audi A3,A4,A5,A6,A7,Q5;Seat Exeo;Skoda Yeti etc.(Engine code;BMK,BPP,CAAA,CAAB,CAAC,CAAD,CAA, CAGA,CAGB,CAGC,CBAB, CBAC,CBDA,CBDB,,CBDC,CDUD)

Design to professionally disconnect/loosen as well as mount/lock the fuel return line push-fit connector(round design)at the injectors. An indispensable tool when removing furl return line push-fit connectors. Incorrect loosening May damage the connector resulting in the complete fuel return line in the engine compartment to be replaced.

KAUPA INTERNATIONAL CO, LTD

PRODUCT DETAIL

ET-9345 OPEN TYPE STEERING KUNCKLE SPREADER TOOL



Description:

- * Made of chrome-moly steel.**
- * Adjustable tool designed for spreading the steering fixed seat of shock absorbers without damaging the aluminum or cast iron knuckle.**
- * Applicable: VAG, BMW, Citroen, FORD, Renault, Seat, Peugeot and most Japanese vehicles.**



2-7, Ln 108 West, Yongfeng Rd., Taiping Dist., Taichung, Taiwan
TEL: 886 4 22778689 FAX: 886 4 22778289

KAUPA INTERNATIONAL CO, LTD

PRODUCT DETAIL

ET-9346 14PCS SLOTTED SPECIAL SOCKET SET



Description:

- * slotted sockets in $3/8$ " DR(10, 11, 12mm) x 6PT x 46mm, $3/8$ " DR(13,14,15,16mm) x 6PT x 64mm, and $1/2$ " DR(17,18,19,20,21,22,24mm) x 6PT x 78mmL
- * for the assembly of top and side wired temperature sensors, thermo switches and other components
- * also suitable for nuts and bolts of bent pipes
- * the slot width is: 7.4 mm(10), 8.8 mm(11), 9.1mm(12), 10.5 mm(13), 11 mm(14), 11 mm(15), 12.3 mm(16) 13.8 mm(17), 14 mm(18) 14.4mm(19), 14.4 mm(20), 15.7 mm(21), 15.7 mm(22) and 16.9 mm(24)



2-7, Ln 108 West, Yongfeng Rd., Taiping Dist., Taichung, Taiwan
TEL: 886 4 22778689 FAX: 886 4 22778289

KAUPA INTERNATIONAL CO, LTD

PRODUCT DETAIL

ET-9347 3/8 DRIVE SOCKET, METRIC, FUEL INJECTOR LINE, CUMMINS ISB

ENGINES, 19MM & 22MM



Description:

The sockets reduce the possibility of fuel leaks and prevent damage to fitting, fuel rail, and fuel line. The 22mm is used on the newest ISX Cummins motors and the 19mm is found on 2011 and older diesel engines. Use with 3/8" square drive.

KAUPA INTERNATIONAL CO, LTD

PRODUCT DETAIL

ET-9348 10PCS OXYGEN SENSOR SOCKET SET



Description:

- * Rethread tool sizes: M12 x 1.25mm and M18 x 1.5mm
- * Vacuum switch socket sizes: 1/2-inch drive 29mm and 3/8-inch drive 22mm
- * Oil sender unit socket sizes: 1-inch and 1 1/16-inch
- * Injector socket size: 1/2-inch drive 27mm
- * Heated oxygen sensor socket size: 1/2-inch drive 22mm
- * Offset oxygen sensor wrench size: 3/8-inch drive 22mm
- * Deep offset oxygen sensor socket size: 1/2-inch drive 22mm

KAUPA INTERNATIONAL CO, LTD

PRODUCT DETAIL

ET-9349 POSITIVE LIFT ACTION CLIP REMOVER PLIERS



***Allows easy access and removal of those hard to reach clips on bumper covers, fender liners etc.**

***Features positive lift action without damage to the clip or the surrounding area.**

***Simply insert the jaws under the clip and squeeze the pliers to remove the clip.**

***Length: 9-1/2"(240mm)**

KAUPA INTERNATIONAL CO, LTD

RODUCT DETAIL

PC-9342 CLAMPING SCREW DISASSEMBLY TOOL



Special tool for loosening the clamping screw on the four-link axle

For VAG vehicles, z. B. AUDI A4, A6 etc.

Can also be used with aluminum steering knuckles

Content:

3 high performance drills (HSS Cobalt), size: 6 8,5 10 mm

1 pressure bar

1 rash tool

KAUPA INTERNATIONAL CO, LTD

PRODUCT DETAIL

TT-9274 PETROL 2.0 T (CHAIN) ENGINE SETTING / LOCKING

KIT-OPEL/VAUXHALL - SAAB



Application:

OPEL-VAUXHALL:

Signum

Vectra-C

SAAB:

9-3 (9440)

2.0T Petrol engines:

B207

B207E

B207L

B207R

Z20NE



2-7, Ln 108 West, Yongfeng Rd., Taiping Dist., Taichung, Taiwan
TEL: 886 4 22778689 FAX: 886 4 22778289

KAUPA INTERNATIONAL CO, LTD

PRODUCT DETAIL

BS-9371 COLD ADHESIVE GLUE PULLING HAMMER SET WITH FOUR ALUMINUM

ALLOY ADAPTOR



The KAUPA BS-9371 Cold Adhesive Glue Paintless Dent Repair kit is reusable in use and practically does not run out. The special composition provides quick, strong adhesion, sufficient to perform a wide range of PDR tasks. The composition is easy to use, even suitable for PDR beginners.

Strong adhesion provides extreme traction combined with easy removal. Upon application the surface must be free of grease. Water and at least 20 degrees Celsius. The kit does not damage the body paintwork, is completely safe to use! The fastening system is suitable for our special design sliding hammer with aluminum alloy adaptor.

Instant strong adhesion! Low cost and quick payback!



2-7, Ln 108 West, Yongfeng Rd., Taiping Dist., Taichung, Taiwan

TEL: 886 4 22778689 FAX: 886 4 22778289

KAUPA INTERNATIONAL CO, LTD

Set contains :

- **1.3kg Sliding hammer with Aluminum alloy Adaptor**
- **Four aluminum alloy adaptor –**
 - Rectangular Adaptor : 36 mm x 80 mm**
 - Rectangular Adaptor : 22 mm x 75 mm,**
 - Round Adaptor : 52mm Diameter**
 - Round Adaptor : 38mm Diameter**
- **50g special cold adhesive glue**

OPERATION :

- 1. Select the proper aluminum alloy adaptor with dent repair area.**
- 2. Open the plastic box with black cold glue, separate small amount apply evenly on the surface of aluminum alloy adaptor, winding the black glue over the edge of adaptor**
- 3. Install the aluminum alloy adaptor on the red handle of the sliding hammer**
- 4. Apply the sliding hammer with adaptor to the repair area, make an effort to apply the black glue evenly stick on the repair area.**
- 5. Proceed to pull the dent out by striking the slide hammer weight against the stop end.**
- 6. Ease away from the painted surface and clean up.**
- 7. Storage with plastic box and anti-adhesive paper for many more repairs.**



2-7, Ln 108 West, Yongfeng Rd., Taiping Dist., Taichung, Taiwan
TEL: 886 4 22778689 FAX: 886 4 22778289

KAUPA INTERNATIONAL CO, LTD

PRODUCT DETAIL

BS-9374 NEW QUIK PORTABLE LED PDR LIGHT BOARD



18" x 7" - 3 LED Ultra Bright with Separates Switches < White / Yellow >

High Quality Aluminum Body

New Design Light Weight Suction Cup

Standard 12 Links With Elbow

Allow Reflection boards replacement

Powered by 110-240V or 12V Cigarette Adapter



2-7, Ln 108 West, Yongfeng Rd., Taiping Dist., Taichung, Taiwan

TEL: 886 4 22778689 FAX: 886 4 22778289

KAUPA INTERNATIONAL CO, LTD

PRODUCT DETAIL

SB-9307 8PCS INSULATED OPEN END WRENCH SET



7-OPEN END WRENCH: 8.10.12.13.14.17.19MM



2-7, Ln 108 West, Yongfeng Rd., Taiping Dist., Taichung, Taiwan
TEL: 886 4 22778689 FAX: 886 4 22778289

KAUPA INTERNATIONAL CO, LTD

PRODUCT DETAIL

SB-9308 9PCS 3/8" INSULATED TOOL SET



7-3/8"DR. SOCKETS:8.10.12.13.14.17.19MM

1- 3/8" RATCHET

1- 3/8" X 100MM EXTENSION



2-7, Ln 108 West, Yongfeng Rd., Taiping Dist., Taichung, Taiwan

TEL: 886 4 22778689 FAX: 886 4 22778289

KAUPA INTERNATIONAL CO, LTD

PRODUCT DETAIL

SB-9309 28PCS INSULATED TOOL SET



1- 3/8"DR. REVERSIBLE RATCHET

1- EXTENSIONS:100MM L

1-3/8"DR.T-HANDLE

9- 3/8"DR. SOCKETS : 7, 8, 10, 12,13,14,17,19,22MM

8-OPEN END WRENCH:7.8.10.12.13.14.17.19MM

1- CABLE KNIFE

2- PLIERS: 8"COMBINATION PLIER POLISH,6"DIAGONAL PLIER POLISH

3- SCREWDRIVERS:PH1*100MM ,PH2*100MM,

SL1.0*5.5*125MM,SL0.8*4.0*100MM

KAUPA INTERNATIONAL CO., LTD No. 2-7, Ln 108 West, Yongfeng Rd., Taiping Dist., Taichung, Taiwan

Email: service@kaupa.com.tw <http://www.kaupa.com.tw>

KAUPA INTERNATIONAL CO, LTD

PRODUCT DETAIL

SB-9312 METRIC SOCKET WRENCH INSERT SET (NON-MARRING)



General automotive use, decorative polished engine components, rims, door thresholds, motorcycles, boats / marine, trucks, bezels, grips / handles, step rails, exhaust / stack components, bumpers, gear shift plates, air cleaner canister, front grill and manufacturing equipment.

KAUPA INTERNATIONAL CO, LTD

PRODUCT DETAIL

PC-9340 47PC SHOCK ABSORBER PISTON ROD TOOL SET-FOR SPRING



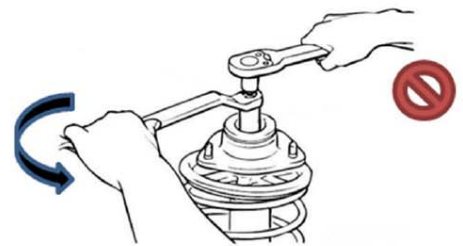
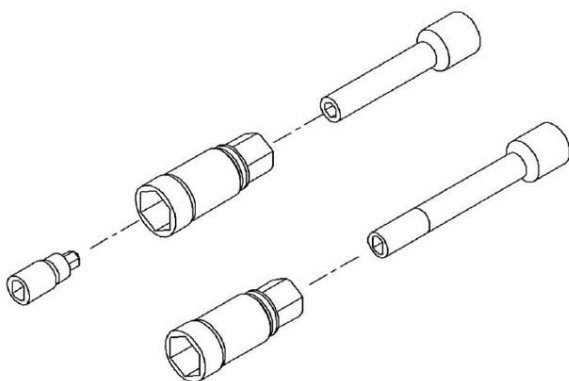







COMPRESSOR & WISHBONE SUSPENSION

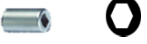

For repair work at the spring strut, shock absorbers, removing strut unit.

For retaining the piston rod when installing and removing strut unit.

*****Content List , with application car see the below*****

					
		Number	Application	SIZE	Application
		PC-9340-5-4	Nissan	4.1×7.1	PC-9340-2-14 Honda, Nissan
Number	Application	PC-9340-5-5.2	Audi, Nissan, VW	5.35×8.1	PC-9340-2-16 Audi, Fiat, SEAT, VW
PC-9340-1		PC-9340-5-6	Audi, Renault, VW	6.2×9.1	PC-9340-2-17 Audi, Ford, Fiat, SEAT, VW
		PC-9340-5-6.3	Nissan	6.45×9.1	PC-9340-2-18 Audi, Ford, Fiat, Japanese car, Opel, Peugeot,
PC-9340-3-6		PC-9340-5-7	Audi, Fiat, SEAT, VW	7.2×10.1	PC-9340-2-19 Audi, Citroen, Fiat, Opel, Peugeot, SEAT, Toyota, VW
PC-9340-3-7	Benz Vaneo	PC-9340-5-8	Fiat, SEAT	8.2×11.2	PC-9340-2-21 Audi, Chrysler, Ford, Japanese car, Benz W203, VW
PC-9340-3-8	BMW, Benz	PC-9340-5-9	Japanese car	9.2×12.1	PC-9340-2-22 Audi, BMW, Citroen, Fiat, Opel, Peugeot,
PC-9340-3-9	Chrysler, Opel Corsa, Astra, Vectra	PC-9340-5-10	Fiat, SEAT, Volvo	10.2×13.2	PC-9340-2-24 Volvo
PC-9340-3-10	Chrysler, Ford	PC-9340-5-12	Fiat, SEAT	12.2×15.2	PC-9340-2-27 Audi, Citroen, Peugeot, VW
PC-9340-3-11	Japanese car				
 Hex Bit Socket		PC-9340-4-5	Nissan, Honda, BMW		 
PC-9340-4-6	BMW, Citroen, Fiat, Ford, Japanese car, Opel, Peugeot, Renault, SEAT	PC-9340-4-7	GM, Vauxhall, Audi, Citroen, Fiat, Benz W203, Renault, SEAT, VW		PC-9340-7-3 3×10, Benz, Opel, Renault
PC-9340-4-8	BMW, Benz	PC-9340-6-M12	Opel, Vauxhall		PC-9340-7-3.5 3.5×10, Chrysler, Citroen, Ford, Peugeot
PC-9340-6-T50	Ford, Nissan	PC-9340-6-T60	Ford		PC-9340-7-4 4×10, Citroen, Peugeot
 D		PC-9340-8-5	Nissan	5×6	PC-9340-8-10 10x12, Nissan, Ford
		PC-9340-10.5x3.5	VW Golf Rear Axle		PC-9340-12.5x3.5 VW Polo Front Axle
PC-9340-14.5x5	Audi 80, VW Polo, Golf, Passat	PC-9340-14.5x3	Austin Maestro		PC-9340-14x2.5 Benz W203(C-Class), W209(CLK)
	pc-9340-9	Bits holder			PC-9340-11-5.5 x 8.2 VW-Audi Golf (IV), TT, BMW, Citroen, Ford, Seat, Skoda, Renault,
	PC-9340-10	Audi 80/90 & Volkswagen Mk 1/II Golf. For front wheel drive vehicles. Use with 22mm socket/spanner.			PC-9340-11-5.0 x 7.0 VW-Audi, BMW, Citroen, Ford, Seat, Skoda, Renault, Peugeot, Japanese car etc.